



# Fraunhofer

IIS

FRAUNHOFER INSTITUTE FOR  
INTEGRATED CIRCUITS IIS

## VIRTUAL ELECTROMAGNETIC ENVIRONMENT AT FORTE

FACILITY FOR OVER THE AIR RESEARCH AND TESTING



IN COOPERATION WITH



TECHNISCHE UNIVERSITÄT  
ILMENAU

# OVER-THE-AIR TESTING IN A VIRTUAL ELECTROMAGNETIC ENVIRONMENT (OTA<sub>in</sub>VEE)

## Virtual Electromagnetic Environments reproduce:

- Realistic multipath propagation environments including spatiotemporal characteristics of the electromagnetic field
- Mobile scenarios (incl. high-speed)
- Arbitrary radio environments and application scenarios
- Coexistence and interference scenarios

## With advantages:

- Reproducibility compared to field tests
- Cost-efficient
- Available at any time and weather independent
- No interference to licenced users (shielded chamber)
- Virtually any location/scenario/prognostic testing in still unavailable bands or uncommissioned systems, incl. "what-if" scenarios
- Non-destructive assessment of integrated multi-antenna system performance

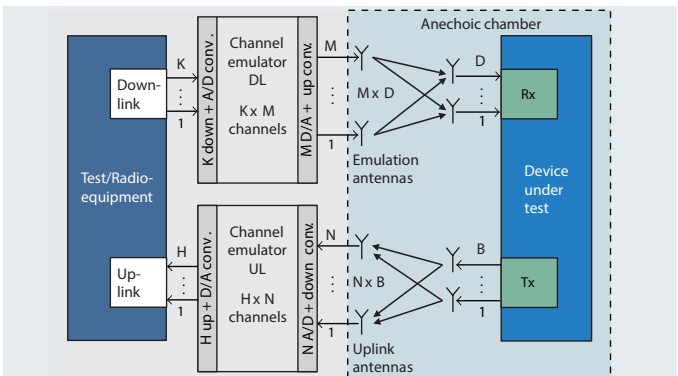

# OTA *in* VEE

## **For testing of:**

- Mobile communication systems (LTE, LTE-A, UMTS, 5G)
- Global navigation systems
- Industrial communication systems
- Cognitive radio systems
- C2I (car to infrastructure), C2C (car to car) systems

## **Especially suited for:**

- Multi-antenna systems
- MIMO (Multiple Input Multiple Output) equipment
- Direction finders
- Communication systems with integrated antennas
- Beam forming antennas
- Controlled-reception-pattern antennas (CRPA)

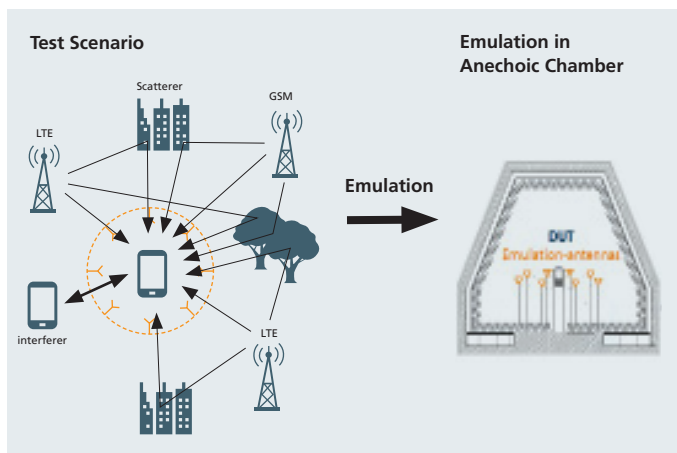

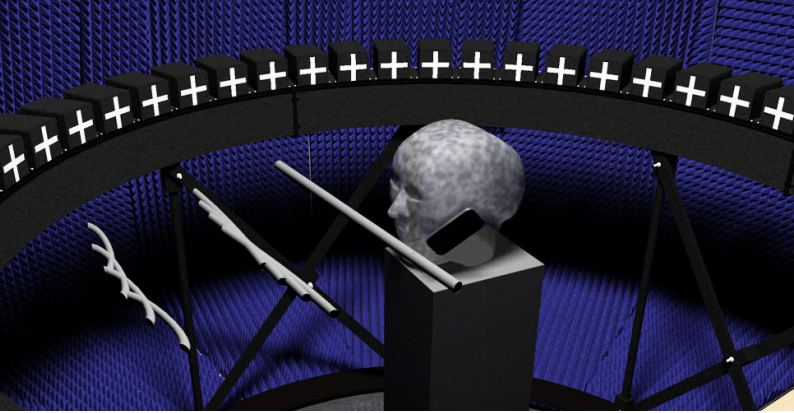

## **OTainVEE TESTBED FEATURES**

### ***Technical information:***

- Frequency range: 350 MHz - 3 GHz (6 GHz)
- Signal bandwidth: 80 MHz
- Maximum RF output power: +10 dBm
- Connectivity: 12 input x 32 output = 384 physical channels
- Two modes of operation:
  - Frequency domain: unlimited number of delay taps
  - Time domain: 32 delay taps per physical channel
- Doppler scenarios with up to 100 kHz Doppler frequency
- Real-time channel convolution with arbitrary multiple radio signals (not just playback)

### ***OTainVEE emulation methods:***

- Two-stage method: conducted test incorporating both the measured radiation pattern of the DUT and the propagation channel
- MIMO-OTA method: 2D/3D full-polarimetric wave field synthesis reproducing the angular characteristics of the channel and assessing DUT antenna performance over the air

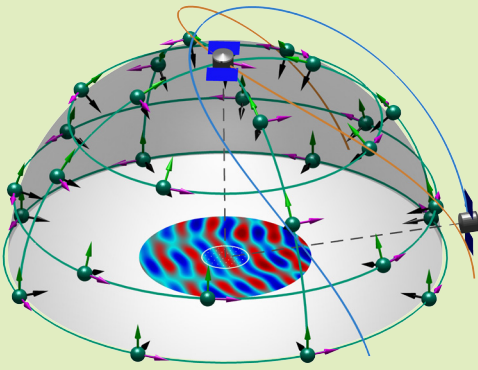

## GLOBAL SATELLITE NAVIGATION SYSTEMS

- GPS/GALILEO/Compass/GLONASS navigation system testing
- Test of
  - Robustness against jammers and spoofers
  - Beam forming/CRPA antennas
  - Impact of multipath propagation
  - Receivers for not fully deployed satellite systems
  - Classified or confidential systems in a shielded environment (e.g., GALILEO PRS)
  - High-speed mobile scenarios

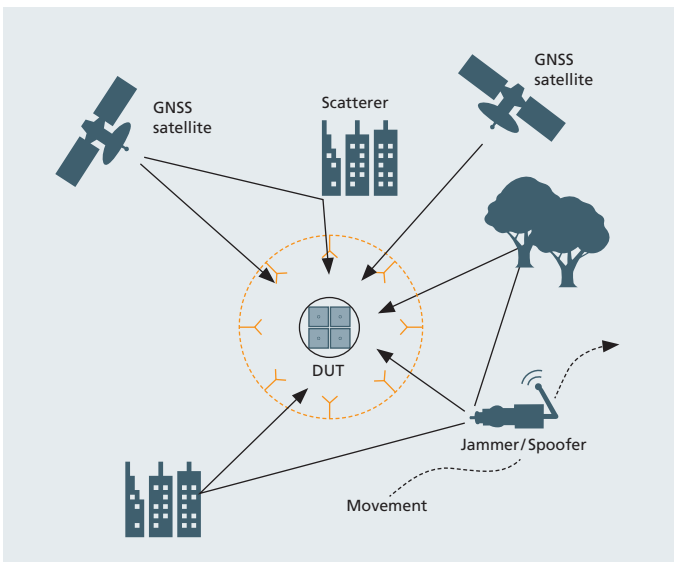

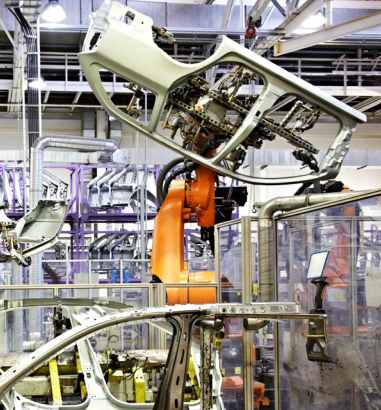

## INDUSTRIAL AND MOBILE COMMUNICATIONS

### ***Industrial Communications***

Emulation of:

- Smart metering scenarios (e.g., automated meter reading, “walk-by” read out)
- Harsh Automation Environments
- Co-existence and interference between different standards
- M2M communication scenarios
- C2X communication

For testing of: Networks, SISO and MIMO systems, LTE, WIFI, Bluetooth

### ***Mobile Communications***

- Single UE and multiple eNB test
- Emulation of complete multi-base station LTE environments with moving multiple-antenna UE under multipath propagation
- Performance, conformance testing of UE (e.g., to industry standards)
- Handover, cooperative multi-point, interference, co-existence, beam forming etc. testing at eNB/UE
- Inter-RAT mobility testing of multi-mode devices
- Complete emulation of co-existing LTE/CMDA/UMTS/GSM, WiFi cells
- Interference management: e.g., between macro UE at cell edge and femto-AP

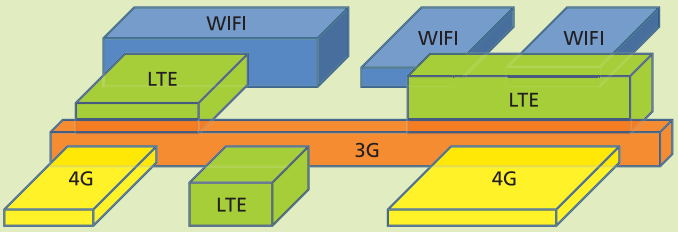

## COGNITIVE RADIO

Emulation of:

- Authentic radio environments
- Various Primary User radio standards, e.g., GSM, LTE, WLAN
- Time, frequency, and spatial channel characteristics of multiple Primary Users
- Secondary User communication partner

For testing of:

- CR prototypes (frequency and spatial domain)
- Interference to primary users
- Network re-establishment and throughput (e.g., after a catastrophe)
- Cognitive cycle (Observe, Orient, Plan, Decide, Act )
- Cognitive Radio units with multiple/beam-forming antennas

